

MIRACLE MAX ROYALE

"Your path to healthy water"



"Your path to healthy water"



CONTENTS

BASIC INFORMATION ABOUT WATER IONIZERS	4
PRODUCT DESCRIPTION	9
IONIZER INSTALLATION	14
FEATURES OF THE DEVICE	15
QUICK GUIDE TO MAIN CONTROL BUTTONS	16
TOUCH PANEL OPERATION	18
INSTRUCTIONS FOR USE	21
MINERAL PORT USE	29
IONIZER CARE	30
HOW TO CHANGE THE FILTER	32
WARNING	34
TROUBLESHOOTING	37
SPECIFICATIONS	40

○ *Minacle Max Royale*

BASIC INFORMATION ABOUT WATER IONIZERS

CONGRATULATIONS ON CHOOSING CHANSON® - THE HIGHEST QUALITY IONIZER BRAND IN THE WORLD! ALL MODELS WE OFFER ARE CUTTING-EDGE PRODUCTS ON THE MARKET. WHEN DEVELOPING CHANSON®, THE GREATEST EMPHASIS WAS PLACED ON ITS SIMPLE MANIPULATION AND INSTALLATION. IT IS SO SIMPLE THAT ANYONE CAN DO IT!

HOW IONIZER WORKS

THE BASIC FUNCTION OF WATER IONIZER IS TO DIVIDE WATER INTO TWO ELECTROLYSIS FORMS:

- ALKALINE WATER
- ACIDIC WATER

THE BASIC PRINCIPLE OF IONIZER IS NOTHING MORE THAN GIVING THE WATER ITS BASIC LIFE FORM. THANKS TO CHARGED ELECTRONS IT IS TURNED INTO ALKALINE LIVING WATER.

EACH IONIZER WE OFFER CONTAINS PLATINUM COATED TITANIUM PLATES (ELECTRODES) WHICH FORM THE ELECTROLYSIS CHAMBER SEPARATED BY CERAMIC DIAPHRAGMS AS DIVIDERS OF POSITIVELY AND NEGATIVELY CHARGED WATER. WATER IONIZERS ARE ALSO KNOWN AS ELECTROLYSIS WATER MACHINES, ION WATER MACHINES, OR ALKALINE WATER MACHINES.

FIRST, THE WATER GOES THROUGH A PRE-FILTRATION, PJ7000 NANOFILTER. IT MAY ALSO BE PRE-FILTERED VIA OPTIONAL ADDITIONAL FILTRATION SYSTEM. THEN, THE PURIFIED WATER GOES THROUGH THE ELECTROLYSIS PROCESS IN THE ELECTRODE BATH WHERE THE IONS ARE SEPARATED INTO TWO PATHS: ALKALINE AND ACIDIC.

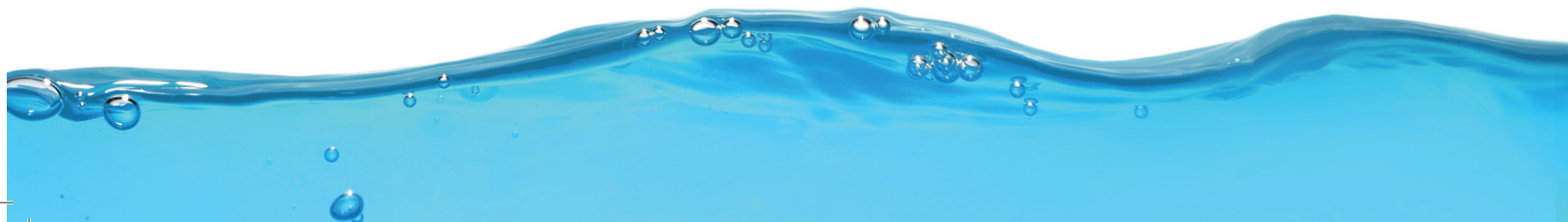

AFTER THE PROCESS OF ELECTROLYSIS, CALCIUM, MAGNESIUM, SODIUM, POTASSIUM, AND OTHER MINERALS ARE DRAWN BY THE NEGATIVE POLE (ALKALINE), AND SULPHURIC ACID AND SULPHUR ARE DRAWN BY THE POSITIVE POLE (ACIDIC). DUE TO AN INCREASE OF HYDROGEN IONS (H+) ACIDIC WATER IS PRODUCED.

NORMALLY, WATER MOLECULES FROM TAP WATER FORM CLUSTERS WITH 12-18 WATER MOLECULES. DURING THE PROCESS OF ELECTROLYSIS, THE HYDROGEN BONDS BETWEEN WATER MOLECULES ARE PARTIALLY OPENED GENERATING 5 TO 6 SMALLER GROUPS OF WATER MOLECULE CLUSTERS. AT THE SAME TIME UNDER THE ACTION OF ELECTRIC FIELD FORCE, CA²⁺, MG²⁺, K⁺ AND OTHER POSITIVE IONS WILL MOVE TOWARDS THE NEGATIVE POLE, AND THE OPPOSITE CL⁻, SO₄²⁻, NO₃⁻, NO₂⁻ AND OTHER NEGATIVE IONS WILL MOVE TOWARDS THE POSITIVE POLE.

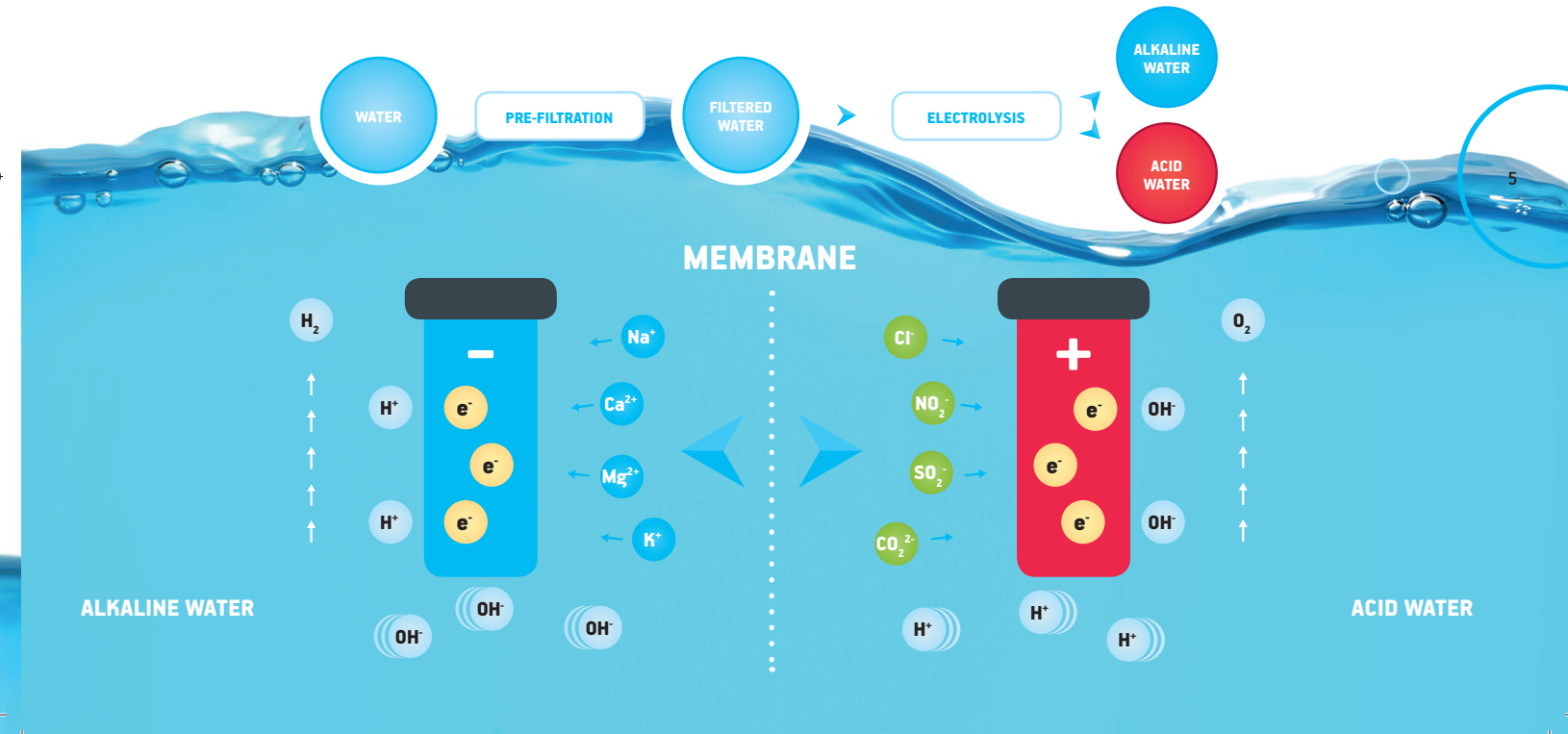



WATER IONS UNDER ELECTROLYSIS PROCESS:

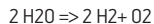

NEGATIVE POLE:

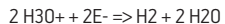

POSITIVE POLE:

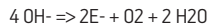

POSITIVELY CHARGED IONS ARE DRAWN BY THE NEGATIVE POLE TO FORM "REDUCED (ALKALINE) WATER" WHERE AVAILABLE ALKALINE MINERALS FROM SOURCE WATER ARE GATHERED. THESE ARE CALCIUM, MAGNESIUM OR POTASSIUM. THIS PURE, HEALTHY ALKALINE WATER WITH SMALL MOLECULE CLUSTERS IS LEAD VIA MAIN STAINLESS STEEL OUTLET TO BE USED FOR DRINKING AND COOKING PURPOSES.

NEGATIVE CHARGED IONS ARE DRAWN BY THE POSITIVE POLE TO FORM "OXIDIZED (ACIDIC) WATER" WHERE ACIDIC MINERALS, SUCH AS NITRATES, SULPHIDES, CHLORIDES AND FLUORIDES FROM SOURCE WATER, GATHER. THIS TYPE OF WATER CAN BE USED FOR MANY UTILITARIAN PURPOSES. IF NOT USED, IT WILL LEAVE VIA DRAIN PIPE.

NEGATIVE POLE (ALKALINE) CREATES A GREATER NUMBER OF ELECTRONS (E-) WHICH PENETRATE THE WATER WE DRINK, WHILE ELECTRONS (E-) PRODUCED BY POSITIVE POLE ARE DRAWN BY ITS POSITIVE CHARGE. UNLIKE THE ALKALINE WATER, ACIDIC WATER CONTAINS NO ELECTRONS. THE PRESENCE OF ELECTRONS IS ALSO CRUCIAL FOR INCREASING NEGATIVE ORP OF ALKALINE WATER.

BENEFITS OF WATER IONIZERS

- ① ALKALINE WATER HELPS NEUTRALIZE ACIDS IN THE BODY, WHICH IS A KEY FOR PREVENTING DISEASES AND IMPROVING YOUR HEALTH, ACCORDING TO MANY EXPERTS;
- ① ALKALINE WATER ACTS AS A POTENT ANTIOXIDANT SEEKING FREE RADICALS BY WHICH IT HELP TO PROTECT YOU AGAINST ILLNESSES AND CHRONIC DISEASES;
- ① THE SIZE OF CLUSTERS OF IONIZED WATER MOLECULES IS SMALLER WHICH ALLOWS MAXIMUM ABSORPTION AND HYDRATION WHILE ACCELERATING METABOLISM WHICH HELPS YOU TO MAINTAIN YOUTH AND HEALTH;
- ① MINERALS PRESENT IN ALKALINE WATER ARE MORE NATURAL AND SUITABLE FOR MAINTAINING THE RECOMMENDED DAILY DOSE OF MINERALS;

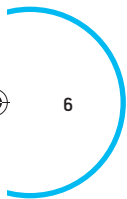

- ① ALKALINE WATER IMPROVES THE TASTE OF FOOD AND IS SUITABLE FOR ALL TYPES OF FOOD PREPARATION AND COOKING;
- ① ACIDIC WATER IS SUITABLE FOR USE IN BEAUTY SALONS, TO WASH YOUR FACE AND OTHER ANTIBACTERIAL PURPOSES.

BENEFITS OF OUR IONIZERS







- ① CHOICE OF PH VALUE FROM 2.4 TO 11.7*;
- ① AUTOMATIC DETECTION OF EXCESSIVE WATER FLOW AND TEMPERATURE SENSOR FOR IONIZER PROTECTION;
- ① POSSIBILITY OF MODULATING THE VALUES OF ORP FROM +1200 TO -920*;
- ① PARENTAL CONTROL LOCK FOR DESIRED PH LEVEL;
- ① AUTOMATIC EVALUATION OF ELECTROLYTIC VALUES ENSURING STABILITY OF SELECTED PH;
- ① AUTOMATIC CHECK OF THE FILTER LIFE DISPLAYED ON LCD SCREEN;
- ① INTELLIGENT AUTOMATIC CLEANING OF ELECTRODES AT EVERY WATER FLOW;
- ① QUALITY OF MATERIALS AND WORKMANSHIP.

* DEPENDING ON WATER QUALITY AND OTHER EXTERNAL FACTORS.

OTHER POSSIBILITIES OF OUR IONIZERS

- ① USE OF MINERAL PORT TO OBTAIN THE MAXIMUM PH AND ORP VALUES (FOR MORE INFORMATION SEE PAGE 29)

○ *Your path to healthy water*

ACID WATER		FILTERED WATER	ALKALINE WATER			
pH 2,5- 4	pH 5,5	pH 7,0	pH 8,5	pH 9,0	pH 9,5	pH 11+
						
<ul style="list-style-type: none"> ① Antibacterial ① Sterilization ① Household cleaning 	<ul style="list-style-type: none"> ① Plant watering ① Beauty use ① Moisturizing 	<ul style="list-style-type: none"> ① pH neutral ① Medication ① Suitable for baby milk preparation 	<ul style="list-style-type: none"> ① Optimal for first time drinking ① Supplies minerals ① Improvement of overall children 's health 	<ul style="list-style-type: none"> ① Suitable for everyday drinking ① Suitable for cooking purposes ① Optimal for coffee and tea preparation ① Hydration when doing sport 	<ul style="list-style-type: none"> ① Everyday drinking ① Cell rejuvenation ① Improvement of chronic health problems ① Elimination of fatigue and tiredness 	<ul style="list-style-type: none"> ① Fruit and vegetable cleaning ① Stain removal ① Dishes cleaning

PH VALUE DEMONSTRATED IN THIS MANUAL CAN DIFFER FROM THE VALUES DISPLAYED ON THE DEVICE DUE TO DIFFERENCES IN THE TAP WATER QUALITY. SHOULD YOU HAVE ANY CONCERNS, PLEASE CONTACT YOUR DEALER.

PRODUCT DESCRIPTION

CONSOLE UNIT

FRONT VIEW

- A** WATER OUTLET CONNECTOR
- B** FAUCET DATA CABLE PS2 CONNECTOR
- C** SIDE FLOW CONTROL VALVE

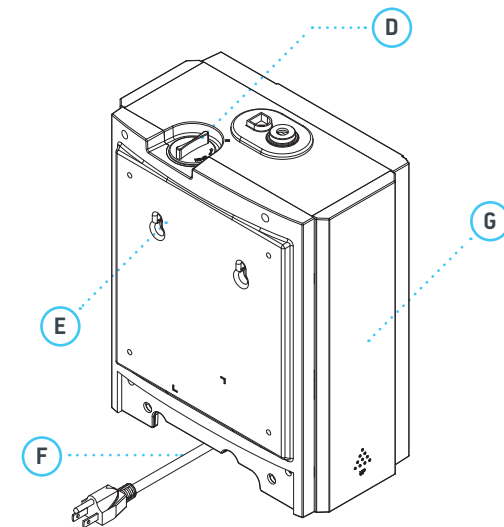
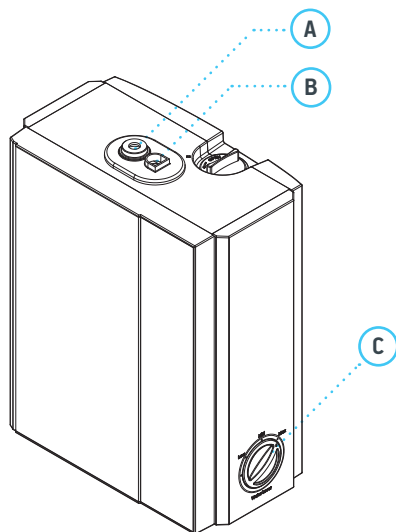

BACK VIEW

- D** MINERAL INSERT PORT
- E** MOUNTING HOLES
- F** POWER CORD
- G** PJ7000 FILTER PANEL (A1 SILVER)

○ *Minacle Max Royale*

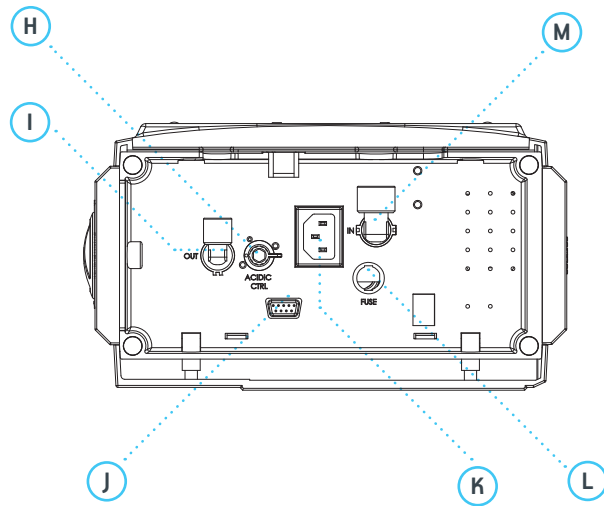

BOTTOM VIEW

H DRAIN FLOW REGULATOR VALVE
I DRAIN WATER OUTLET

J SOFTWARE UPDATE CONNECTOR
K AC SOCKET

L FUSE
M SOURCE WATER INLET

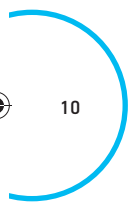

DIGITAL FAUCET

FRONT VIEW

- A FAUCET WATER OUTLET
- B LED BACKLIT TOUCH PANEL

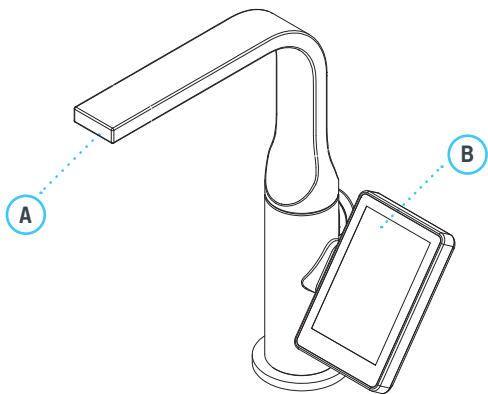

BACK VIEW

- C SPEAKER
- D RESET BUTTON

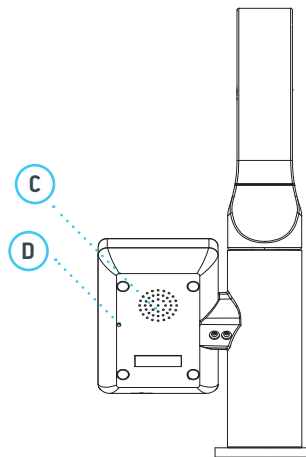

○ *Your path to healthy water*

BASIC INSTALLATION SCHEME

DIAGRAM

- A** DRAIN OUTLET
- B** WATER OUTLET TO DIGITAL FAUCET
- C** DATA CABLE
- D** SOURCE WATER INLET TO PRE-FILTRATION (PRE-FILTRATION SYSTEM IS OPTIONAL EQUIPMENT AND IS NOT PART OF THE IONIZER PACKAGE)
- E** WATER INLET TO WATER IONIZER AFTER PRE-FILTRATION

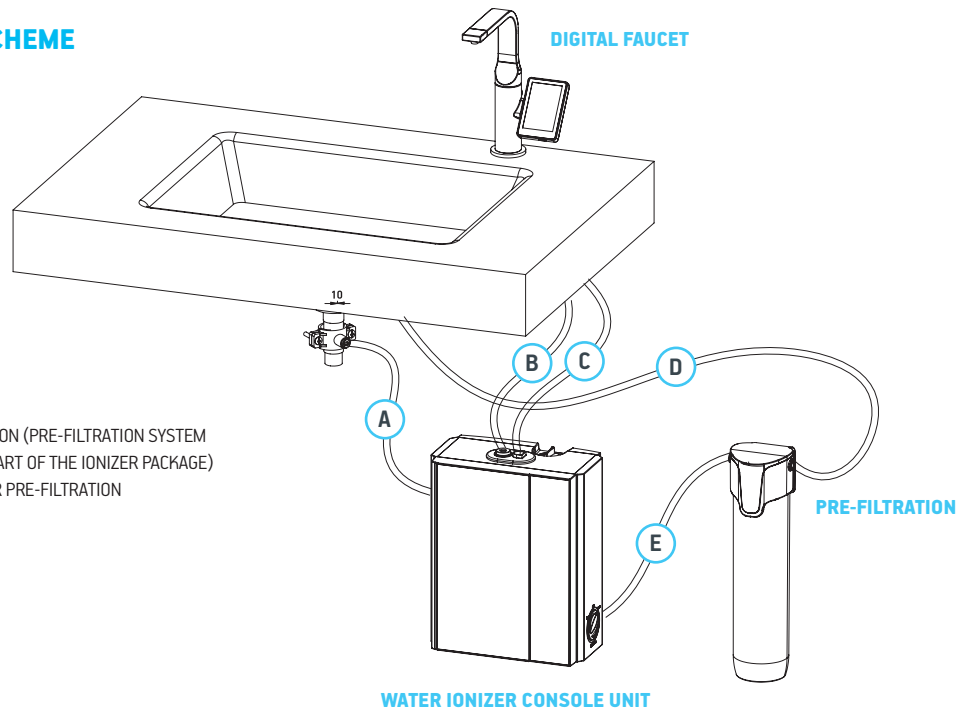

INSTALLATION ACCESSORY KIT

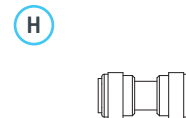
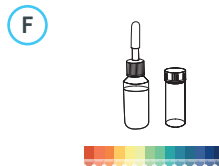
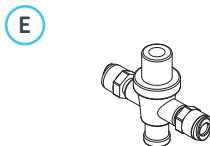
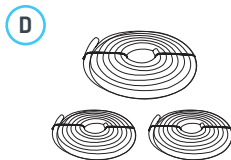
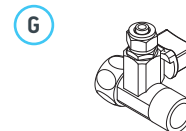
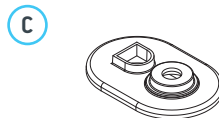
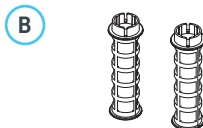
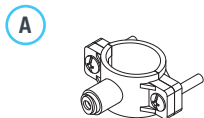

ACCESSORY

A DRAIN SADDLE (Ø 1/4" QUICK CONNECT)

B MINERAL INSERT BASKET - ONE INSTALLED IN THE DEVICE

C SILICON RUBBER GASKET FOR DATA CABLE AND WATER OUTLET (Ø 3/8")

D 150 CM TUBE (Ø 1/4") - 2 ROLLS; 150 CM TUBE (Ø 3/8") - 1 ROLL

E PRESSURE REDUCER (Ø 1/4" QUICK CONNECT)*;

F PH REAGENT DROPS KIT (PH REAGENT DROPS, PH TESTING BOTTLE, COLOUR CHART)

G WATER SOURCE BALL VALVE (Ø 1/4" OUTLET)

H FAUCET INLET CONNECTOR (Ø 3/8" QUICK CONNECT)

NOTE:

* WATER OUTPUT PRESSURE CANNOT EXCEED 70 PSI. THEREFORE IT IS ESSENTIAL THAT THE PRESSURE REDUCER IS INSTALLED. OTHERWISE, YOU RISK LOSING YOUR WARRANTY.

○ *Minacle Max Royale*

IONIZER INSTALLATION

FAUCET PLACEMENT:

- 1 SELECT A SPACE FOR THE FAUCET AND MARK IT;
- 2 USE A HAND DRILL WITH A BIT OF Ø 35MM;
- 3 DRILL A HOLE.

ADJUSTING AND CONNECTING FAUCET TO CONSOLE UNIT:

- 1 PLACE THE FAUCET INTO THE HOLE;
- 2 TIGHTEN THE NUT;
- 3 ATTACH THE DATA CABLE TO THE CONSOLE UNIT FROM ABOVE;
- 4 ATTACH THE QUICK CONNECT FROM THE BOTTOM TO CONNECT THE FAUCET WITH THE CONSOLE UNIT;
- 5 ATTACH THE TUBE OF Ø 3/8" TO THE CONSOLE UNIT AND THE FAUCET;
- 6 TO INCREASE PRODUCTION OF EXTREME VALUES OF THE IONIZED WATER, IT IS POSSIBLE TO PLACE A BALL VALVE BETWEEN THE WATER OUTLET AND QUICK CONNECT (SEE THE PICTURE)

ATTACHING IONIZER TO SOURCE WATER INLET:

- 1 SHUT OFF THE WATER SUPPLY;
- 2 CONNECT THE WATER SOURCE BALL VALVE TO THE COLD WATER SOURCE INLET.
- 3 ATTACH THE 1/4" MM TUBE TO THE OUTLET ON THE VALVE.
- 4 IF YOU ARE USING OPTIONAL ADDITIONAL PRE-FILTRATION SYSTEM, IT IS NECESSARY TO CONNECT IT TO THE SYSTEM AT THIS POINT, IF NOT, SKIP THIS POINT.
- 5 ATTACH THE TUBE TO THE SOURCE WATER INLET ON THE IONIZER (IN).
- 6 CONNECT THE DRAIN OUTLET TUBE TO THE DRAIN WITH DRAIN SADDLE.
- 7 ATTACH THE 1/4" MM DRAIN OUTLET TUBE TO THE DRAIN WATER OUTLET ON THE IONIZER (OUT).

NOTE:

DEALER TAKES NO RESPONSIBILITY FOR THE BAD FUNCTIONING OF THE DEVICE OR ACCIDENTS CAUSED BY FAULTY INSTALLATION.

FEATURES OF THE DEVICE



LEAD FREE METAL FAUCET



DURABLE AND ELEGANT
FAUCET DESIGN



MINERAL INSERT PORT



HVGA MULTI-COLOUR
TOUCHSCREEN (3.5")



AUTOMATIC SLEEP MODE
DESIGNED FOR
POWER CONSERVATION



MULTI LANGUAGE MENU



EASY, USER-FRIENDLY TOUCH
INTERFACE



WATER FLOW ADJUSTING VALVE



PH LOCK FUNCTION



Your path to healthy water

QUICK GUIDE TO MAIN CONTROL BUTTONS



ACIDIC WATER

WATER OUTPUT - ON/OFF

SETTINGS

ALKALINE WATER

FILTERED WATER

LOCK



ACIDIC WATER BUTTON

3 LEVELS OF ACIDIC WATER

- ① ACIDIC 1 (LOW ACIDIC): BEAUTY USE, FACE WASH, MOISTURIZING;
- ① ACIDIC 2 (MILD ACIDIC): USED AS DETERGENT;
- ① ACIDIC 3 (STRONG ACIDIC): KILLS GERMS AND BACTERIA, STERILIZATION.



FILTER WATER BUTTON

- ① FILTERED WATER WITH NO IONIZATION;
- ① USED FOR MEDICATION;
- ① USED FOR BABY MILK.



ALKALINE WATER BUTTON

4 LEVELS OF ALKALINE WATER

- ① ALKALINE 1 (LOW ALKALINE): IDEAL FOR INITIAL DRINKER;
- ① ALKALINE 2 (MILD ALKALINE): USED FOR COOKING;
- ① ALKALINE 3 (STANDARD ALKALINE): USED FOR DAILY DRINKING;
- ① ALKALINE 4 (STRONG ALKALINE): USED FOR FRUIT AND VEGETABLE CLEANING.



WATER OUTPUT BUTTON

PRESS WATER OUTPUT BUTTON TO TURN ON THE DEVICE. BY PRESSING AGAIN THE DEVICE WILL TURN ITSELF OFF.



LOCK BUTTON

SELECT THE DESIRED WATER LEVEL, PRESS AND HOLD LOCK BUTTON FOR 3 SECONDS AND YOU WILL SEE THE LOCK CHANGE FROM UNLOCK TO LOCK. PRESS AND HOLD FOR 3 SECONDS TO UNLOCK.



SETTINGS

PRESS SETTINGS BUTTON TO ENTER SETTINGS MODE FOR LANGUAGE, VOLUME, LEVEL OF ELECTROLYSIS, FILTER SERVICE, SYSTEM RESET AND OTHER INFORMATION.

TOUCH PANEL OPERATION



A MODE



ELECTROLYSIS IN PROGRESS



WATER DISPENSING



STAND BY



SELF-CLEANING IN PROGRESS

B ACIDIC WATER BUTTON

ACIDIC 1 (LOW ACIDIC): BEAUTY USE, FACE WASH, MOISTURIZING;

ACIDIC 2 (MILD ACIDIC): USED AS DETERGENT;

ACIDIC 3 (STRONG ACIDIC): KILLS GERMS AND BACTERIA, STERILIZATION;

C FILTER WATER BUTTON

FILTERED WATER WITH NO IONIZATION;

D SETTINGS

PRESS SETTINGS BUTTON TO ENTER SETTINGS MODE FOR LANGUAGE, VOLUME,
LEVEL OF ELECTROLYSIS, FILTER SERVICE, SYSTEM RESET AND OTHER INFORMATION;

E PH DISPLAY

SHOWS PH OF SELECTED WATER LEVEL;

F ALKALINE WATER BUTTON

ALKALINE 1 (LOW ALKALINE): IDEAL FOR INITIAL DRINKER;

ALKALINE 2 (MILD ALKALINE): USED FOR COOKING;

ALKALINE 3 (STANDARD ALKALINE): USED FOR DAILY DRINKING;

ALKALINE 4 (STRONG ALKALINE): USED FOR FRUIT AND VEGETABLE CLEANING.

G WATER OUTPUT BUTTON



MACHINE HAS STOPPED ELECTROLYSIS PROCESS;



MACHINE HAS STOPPED DISPENSING;



MACHINE ON STAND-BY (READY TO BE USED);



SELF-CLEANING IN PROGRESS;

H LOCK BUTTON



THE SELECTED LEVEL OF WATER IS ACTIVATED AND LOCKED;



UNLOCKED. USER CAN SELECT ANY LEVEL;

○ *Your path to healthy water*

I FILTER LIFE INDICATOR

THE LIFE OF THE FILTER IS 9000L OR 1 YEAR WHICHEVER COMES FIRST. THE AMOUNT OF 9000 LITRES REPRESENTS AVERAGE FILTER CAPACITY (DEPENDING ON WATER QUALITY). AS SOON AS 9000 LITRES ARE USED, THE INDICATOR WILL ALARM FOR FILTER CHANGE. IF 1 YEAR IS REACHED BEFORE 9000 LITRES HAS BEEN USED, THE INDICATOR WILL ALSO ALARM FOR FILTER CHANGE.



INSTRUCTIONS FOR USE

PLUG IN POWER CABLE

- IONIZER WILL TURN ON AUTOMATICALLY ONCE POWER CABLE IS PLUGGED IN.
- IONIZER WILL BE ON STAND-BY FOR ABOUT 1 MINUTE. IF DURING THAT TIME NO LEVEL OF ELECTROLYSIS IS SELECTED OR NO OTHER ACTION TAKEN, THE DEVICE WILL AUTOMATICALLY GO INTO SLEEP MODE. TOUCH THE SCREEN ANY TIME TO ACTIVATE THE DEVICE. IT IS IMMEDIATELY READY TO BE USED.

SAFETY FUNCTION

- IONIZER WILL AUTOMATICALLY TURN OFF WATER WHEN CONTINUOUSLY DISPENSING FOR 15 MINUTES.
- IONIZER WILL AUTOMATICALLY GO INTO SELF-CLEANING MODE AFTER 30 LITRES OF IONIZED WATER IS CONSUMED. THE SELF-CLEANING INTERVAL CAN BE ALTERED IN MENU.
- AFTER STRONG ACIDIC WATER IS USED, THE IONIZER WILL GO INTO SELF-CLEANING MODE WHEN USER SELECTS A DIFFERENT LEVEL.

ALKALINE/FILTERED/ACIDIC WATER USE GUIDE

SELECTING LEVEL OF IONIZATION

A SELECT ALKALINE BUTTON „ALKALINE“
SELECT 1 FROM 4 LEVELS:



B SELECT FILTER BUTTON



„FILTERED“

C SELECT ACID BUTTON



„ACIDIC“

SELECT 1 FROM 3 LEVELS:



MOISTURIZING



WASHING / CLEANING



STERILIZING



START WATER OUTPUT

AFTER SELECTING DESIRED LEVEL, PRESS  TO OUTPUT WATER.

INDICATOR  INFORMS YOU THAT ELECTROLYZED WATER WILL START

DISPENSING IN A FEW SECONDS. PRESS  AGAIN TO STOP WATER DISPENSING.



CHANGING LEVELS WHILE WATER IS DISPENSING

YOU CAN CHANGE THE SELECTED WATER LEVEL AT ANY POINT OF THE ELECTROLYSIS PROCESS

BY PRESSING  TO CONFIRM SELECTED LEVEL. THIS DOES NOT INCLUDE STRONG ACIDIC LEVEL WHERE THE ELECTROLYSIS PROCESS MUST TERMINATE BEFORE SELECTING THIS LEVEL.



LOCK BUTTON

STEP 1

SELECT THE PH LEVEL THAT YOU WOULD LIKE TO STAY LOCKED ON.

STEP 2

PRESS AND HOLD  FOR 3 SECONDS.

YOU WILL HEAR A VOICE PROMPT AND THE LOCK SIGN WILL CHANGE TO 

YOU WILL NOT BE ABLE TO CHANGE TO OTHER LEVELS WHEN LOCK KEY IS ACTIVATED.

STEP 3

TO UNLOCK, PRESS AND HOLD  FOR 3 SECONDS.

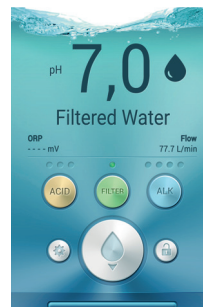

WHEN LOCK KEY IS ACTIVATED

Your path to healthy water

FILTER SERVICE/FILTER RESET

WHEN THE FILTER LIFE INDICATOR REACHES 1 BLOCK, THE INDICATOR WILL BE FLASHING IN RED. YOU WILL HEAR "PLEASE BE READY TO CHANGE FILTER" EVERY TIME YOU FINISH USING THE IONIZER. THIS IS TO REMIND YOU IT IS ALMOST TIME TO CHANGE THE FILTER.

WHEN FILTER LIFE INDICATOR BAR IS EMPTY, IT IS NECESSARY TO CHANGE THE FILTER. THE FILTER LIFE INDICATOR WILL BE FLASHING IN RED. YOU WILL HEAR "PLEASE CHANGE FILTER" EVERY TIME YOU FINISH USING THE IONIZER.



FILTER CHANGE REQUIRED SOON



FILTER CHANGE REQUIRED SOON

SETTINGS

PRESS  TO ENTER SETUP MODE



LANGUAGE
LANGUAGE SETTING:
YOU CAN SELECT FROM THE LANGUAGES AVAILABLE.

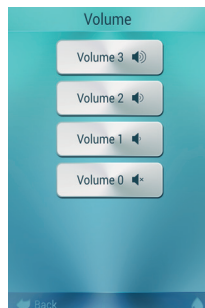

VOLUME
SELECT THE DESIRED
VOLUME LEVEL.

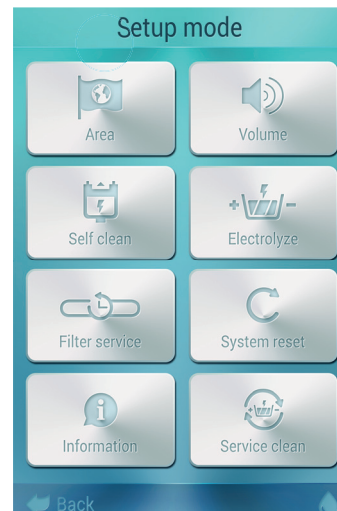

PRESS THE WATER DROP SIGN  TO RETURN TO THE MAIN SCREEN. PRESS  TO RETURN TO THE LAST PAGE.

 *Minacle Max Royale*

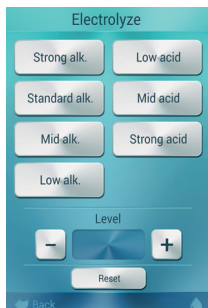

ELECTROLYZE

PRESS AND

TO SELECT WATER LEVEL AND CHANGE POWER OF ELECTROLYSIS.

PRESS RESET KEY TO REVERT TO FACTORY DEFAULT ELECTROLYZE SETTING. PLEASE CONSULT YOUR CHANSON DEALER PRIOR TO THIS SETTING.

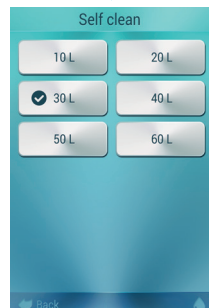

SELF CLEAN

SELECT THE DESIRED FREQUENCY OF SELF-CLEAN CYCLE (OPTIONS FROM 10 TO 60 LITRES). THE DEFAULT SETTING FOR THE SELF-CLEANING FREQUENCY IS 30 LITRES.

DUE TO DIFFERENCES IN WATER QUALITY IN DIFFERENT AREAS, WE RECOMMEND TO CAREFULLY CONSIDER ADJUSTING THE SELF-CLEANING FREQUENCY OR TO CONSULT AUTHORIZED CHANSON DEALER.

PRESS THE WATER DROP SIGN TO RETURN TO THE MAIN SCREEN. PRESS TO RETURN TO THE LAST PAGE.



Filter service

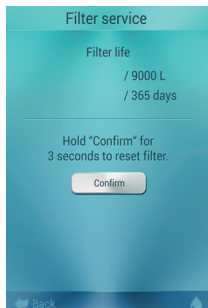

FILTER SERVICE

FILTER OF THE DEVICE SHOULD BE CHANGED WHEN FILTER LIFE REACHES "0" L (LITRE) OR "0" DAYS, WHICHEVER SHOWS UP FIRST.

PRESS AND HOLD CONFIRM BUTTON FOR 3 SECONDS TO CONFIRM FILTER LIFE RESET. FILTER COUNTER WILL RESET TO DEFAULT SETTING.



System reset

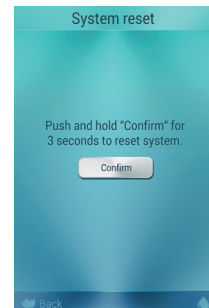

SYSTEM RESET

PRESS AND HOLD RESET BUTTON FOR 3 SECONDS TO RESET ALL SETTINGS OF THE IONIZER BACK TO FACTORY DEFAULT SETTINGS.

PLEASE CONSULT YOUR CHANSON DEALER PRIOR TO SELECTING THIS FUNCTION.

PRESS THE WATER DROP SIGN  TO RETURN TO THE MAIN SCREEN. PRESS  TO RETURN TO THE LAST PAGE.

Your path to healthy water



Information

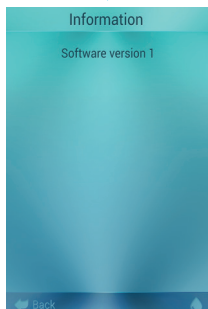

INFORMATION

THIS PAGE IS TO DISPLAY THE VERSION OF SOFTWARE YOU ARE USING.



Service clean



SERVICE CLEAN

PRESS AND HOLD THE "SERVICE CLEAN" ICON FOR 5 SECS TO ACTIVATES THE CITRIC CLEAN PROCESS.

ONCE THE CLEANING PROCESS ACTIVATES, THE SCREEN WILL TURN INTO THE STARTUP PAGE WITH CHANSON LOGO.

COUNT DOWN METER SHOWING HOW MUCH TIME IS LEFT (COUNT DOWN FROM 2130 SECS) TO COMPLETE THE TOTAL 35 MINS CLEANING PROCESS. WHEN 35 MINS CLEANING IS FINISHED, THE MACHINE WILL RETURN TO THE NORMAL OPERATION SCREEN.

PRESS THE WATER DROP SIGN  TO RETURN TO THE MAIN SCREEN. PRESS  TO RETURN TO THE LAST PAGE.



MINERAL PORT USE

IT IS NOT COMPULSORY TO USE MINERAL PORT. IT IS A BONUS FOR THOSE WHO LIVE IN THE AREA WITH SOFT WATER OR THOSE WHO WANT TO MAKE EXTREMELY ALKALINE OR ACIDIC WATER ONCE IN A WHILE. IT IS NOT RECOMMENDED TO DO IT MORE OFTEN DUE TO POSSIBLE CLOGGING AND CLEANING OF THE ELECTRODES OF THE DEVICE AFTERWARDS. IF YOU DESIRE TO MAKE EXTREMELY ALKALINE OR ACIDIC WATER, MAKE A LARGER AMOUNT AND STORE IT.



FOR THE PRODUCTION OF EXTREMELY ALKALINE WATER USE CALCIUM OR OTHER ALKALIZING MINERAL OF PHARMACEUTICAL QUALITY IN LARGER CRYSTALS. FOR THE PRODUCTION OF EXTREMELY ACIDIC WATER USE HIMALAYAN ROCK SALT. HIMALAYAN ROCK SALT OR ANY OTHER MINERALS DO NOT FORM A PART OF THE PACKAGE, BUT IT IS POSSIBLE TO OBTAIN THEM AT YOUR LOCAL DEALER OF ZIVAVODA.CZ OR IN A SPECIALIZED SHOP.

IN CASE YOU DESIRE TO PRODUCE WATER OF EXTREME PH AND ORP VALUES, ALWAYS SELECT THE HIGHEST POWER LEVELS (ALKALINE 4 AND ACIDIC 3), LOWER THE WATER FLOW WITH CONTROL VALVE PLACED ON THE SIDE OF THE DEVICE (OR THE BALL VALVE) TO THE MINIMUM AND INSERT THE CHOSEN MINERAL IN THE MINERAL BASKET ACCORDING TO INSTRUCTIONS BELOW:

NOTE:

- 1 BY USING LOW-QUALITY MINERALS YOU CAN DAMAGE THE IONIZER, WHICH CAN LEAD TO LOSS OF WARRANTY.
- 2 DO NOT USE HIMALAYAN ROCK SALT OR OTHER MINERALS WITH ANY DEVICES EXCEPT WITH CHANSON MIRACLE MAX OR MIRACLE MAX ROYALE
- 3 DO NOT USE ORDINARY TABLE SALT!

IF THE SALT DOES NOT DISSOLVE COMPLETELY DURING THE PROCESS OF WATER PRODUCTION, EMPTY THE MINERAL BASKET IN THE PORT, CLEAN IT SO THERE ARE NO RESIDUES LEFT AND PLACE IT BACK TO THE DEVICE. THE IONIZER CAN BE USED NORMALLY AGAIN.

- 1 MAKE SURE THE POWER BUTTON IS OFF AND THE DEVICE IS ON STANDBY OR IN SLEEP MODE.
- 2 OPEN THE CAP OF THE MINERAL PORT AND PULL OUT THE BASKET (WHITE COLOUR).
- 3 FILL THE BASKET WITH MINERAL UP TO 20-80% OF THE CONTAINER VOLUME.
- 4 INSERT THE BASKET BACK TO THE PORT AND PRESS IT DOWN AT THE END. TURN THE CAP CLOCKWISE AND TIGHTEN IT FIRMLY.
- 5 SELECT ONLY ACIDIC 3 LEVEL OF WATER WHEN USING HIMALAYAN ROCK SALT OR ONLY ALKALINE 4 LEVEL OF WATER WHEN USING CALCIUM OR OTHER MINERALS. PRESS THE BUTTON FOR WATER PRODUCTION.



○ *Miracle Max Royale*



IONIZER CARE

DUE TO WATER FLOW, IT IS NATURAL FOR THE IONIZER TO SLOWLY CLOG. IT IS THEREFORE ESSENTIAL TO GIVE IT'S CARE DUE ATTENTION. ALTHOUGH THE DEVICE IS EQUIPPED WITH AUTOMATIC SELF CLEANING SYSTEM, IT IS ALSO RECOMMENDED TO PREVENTIVELY PERFORM ADDITIONAL CLEANING WITH CITRIC ACID AT LEAST ONCE EVERY TWO MONTH, MORE OFTEN IN AREAS WITH HARD WATER.

HOW TO CARE FOR YOUR IONIZER PROPERLY? EASY, JUST USE SERVICE CLEAN FUNCTION.

TO ENSURE THAT YOUR IONIZER FUNCTIONS IN THE MOST EFFECTIVE WAY, IT IS ESSENTIAL TO PREVENT ITS CLOGGING BY IMPURITIES FROM WATER AND SEDIMENTS NATURALLY PRODUCED DURING THE IONIZATION PROCESS.

IT IS RECOMMENDED TO PERFORM SERVICE CLEANING EVERY 2 MONTHS TO MAINTAIN YOUR WATER IONIZER AT BEST PERFORMANCE AND TO PREVENT CALCIUM BUILTUP INSIDE ELECTROBATH.

POUR CITRIC ACID POWDER TO THE INDICATED LEVEL LABELED ON THE CARTRIDGE. CLOSE CARTRIDGE CAP SECURELY AND INSTALL THE CITRIC CARTRIDGE ON THE IONIZER (SAME WAY WHEN REPLACING FILTER).

PLEASE REFER TO THE INSTRUCTION ON THE CHANSON C-CLEAN KIT WHEN PERFORMING SERVICE CLEAN.

CLEANING IS SIMPLE AND WITHOUT ADDITIONAL ACTIONS

- 1 REMOVE THE SIDE PANEL OF THE CONSOLE UNIT PLACED UNDER THE KITCHEN DESK AND REMOVE „PJ7000“ FILTER.
- 2 OPEN C-CLEAN CARTRIDGE AND INSERT CITRIC ACID TO THE „FILL TO HERE“ INDICATOR ON THE CARTRIDGE.

*** REPLACE THE WHITE FILTER PAD (PP CLOTH) LOCATED AT THE BOTTOM OF THE C-CLEAN CARTRIDGE WHEN NECESSARY. THERE ARE EXTRA PADS INCLUDED IN THE C-CLEAN PACKAGE.

3 CLOSE C-CLEAN CARTRIDGE FIRMLY.

4 INSERT C-CLEAN CARTRIDGE INTO THE IONIZER FILTER BY LINING UP THE „IN“ ARROW TO THE MID POINT AND PUSH DOWN FIRMLY. TURN CARTRIDGE CLOCKWISE TO WHERE THE „LOCK“ MEETS THE MID POINT.

5 ACTIVATE SERVICE CLEAN FUNCTION IN SETUP MODE OF THE DEVICE (SEE PAGE 25). FOR ACTIVATION PRESS AND HOLD THE SERVICE CLEAN ICON FOR 5 SECONDS. ONCE THE CLEANING PROCESS ACTIVATES, THE SCREEN WILL TURN INTO THE STARTUP PAGE WITH CHANSON LOGO. COUNT DOWN METER SHOWING HOW MUCH TIME IS LEFT (COUNT DOWN FROM 21 30 SECS) TO COMPLETE THE TOTAL 35 MINS CLEANING PROCESS.

6 ONCE SERVICE CLEAN IS FINNISHED REMOVE CLEANING CARTRIDGE AND INSERT „PJ7000“ FILTER AND SIDE PANEL BACK.

TIPS AND ADVICE

A OUR WATER IONIZERS ARE SET TO SELF-CLEAN AFTER EVERY 10-60 LITRES OF USED WATER, THEREFORE IT IS NOT ESSENTIAL TO TAKE FURTHER ACTION APART FROM REGULAR FILTER CHANGE WHICH THE DEVICE WILL INFORM YOU ABOUT.

B IF YOU LIVE IN THE AREA WITH POOR QUALITY WATER IT IS RECOMMENDED TO PURCHASE A PRE-FILTRATION SYSTEM. CONTACT YOUR DEALER TO NEGOTIATE THE MOST FAVOURABLE TERMS.

NOTE:

IN CASE THE DEVICE IS NOT PROPERLY CARED FOR, IT CAN BLOCK ITSELF. DAMAGE CAUSED BY BLOCKAGE OF THE DEVICE OR IMPROPER CARE IS NOT COVERED BY THE WARRANTY AND IN SUCH CASES THE RESPONSIBILITY LIES WITH THE OWNER OF THE DEVICE.

○ *“Your path to healthy water”*

HOW TO CHANGE THE FILTER

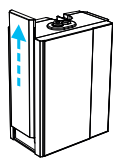

- 1** LOOKING AT THE IONIZER FROM THE FRONT, REMOVE THE LEFT PANEL BY SLIDING IT UPWARDS.

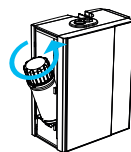

- 2** UNLOCK THE FILTER BY TURNING IT ANTICLOCKWISE

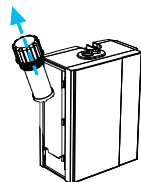

- 3** REMOVE THE FILTER



- 4** INSERT THE NEW FILTER

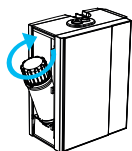

5 LOCK THE NEW FILTER BY TURNING IT
ANTICLOCKWISE

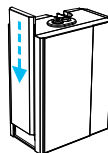

6 SLIDE THE PANEL DOWNWARDS
TO ITS ORIGINAL PLACE

7 DO THE FILTER SERVICE RESET
(SEE FILTER COUNT RESET INSTRUCTIONS, P. 27)

WARNING

IT IS ESSENTIAL TO FOLLOW THE INSTRUCTIONS

- ① IT IS IMPORTANT TO MAKE SURE TO CLOSE ALL WATER SUPPLIES AND TO UNPLUG THE IONIZER FROM POWER OUTLET IF YOU WILL NOT BE USING IT FOR AN EXTENDED PERIOD OF TIME.
- ① DO NOT TRY TO REPAIR OR MODIFY ANY PART OF THE IONIZER YOURSELF. YOU RISK VOIDING THE WARRANTY.
- ① DO NOT PLUG AND UNPLUG THE IONIZER FROM THE POWER OUTLET REPEATEDLY. THIS CAN CAUSE ELECTRICAL DAMAGE TO THE DEVICE AND YOU RUN THE RISK OF LOSING WARRANTY.
- ① DO NOT USE WORN OR DAMAGED CABLE CORD. CONTACT YOUR DEALER FOR REPLACEMENT.
- ① REMOVE ANY DUST AND DRY ANY WATER FROM THE POWER CORD AS THIS CAN CAUSE ELECTRICAL PROBLEMS AND COULD BE THE CAUSE OF FIRE.
- ① DO NOT USE EXCESS OF WATER OR ANY ABRASIVE CLEANER TO CLEAN ANY PART OF THE IONIZER. MAKE SURE THE IONIZER IS UNPLUGGED FROM THE POWER OUTLET WHEN CLEANING IT. THIS WILL HELP PREVENT DAMAGES TO IONIZER 'S BODY OR ELECTRONICS.
- ① DO NOT INSTALL THE IONIZER IN AREAS OF EXTREME COLD OR HEAT.
- ① IF YOU NOTICE ANY LEAKS FROM THE DEVICE, CLOSE THE WATER SUPPLY IMMEDIATELY AND UNPLUG THE IONIZER FROM THE POWER OUTLET. CONTACT YOUR DEALER FOR ASSISTANCE.
- ① IN CASE ATYPICAL NOISES COME FROM THE DEVICE OR THE DEVICE FUNCTIONS IN NON-STANDARD WAY, UNPLUG IT FROM THE POWER OUTLET AND CONTACT TECHNICAL SUPPORT FOR ASSISTANCE.
- ① DO NOT PLACE ANY OBJECTS THAT CAN CREATE FIRE CLOSE TO THE IONIZER AS THIS COULD CAUSE DAMAGE TO THE DEVICE.
- ① WHEN MOVING THE IONIZER, UNPLUG THE DEVICE FROM THE POWER OUTLET FIRST. DO NOT PULL THE CORD, IT MAY COME OFF FROM THE POWER OUTLET OR

- ① FROM THE POWER CORD CONNECTION UNDERNEATH THE IONIZER AND CAUSE ELECTRICAL DAMAGE.
- ① DO NOT PLUG THE IONIZER IF ELECTRICAL SOCKET ON THE IONIZER OR POWER OUTLET ARE LOOSE. THIS WAY YOU WILL AVOID ELECTRICAL DAMAGE OR FIRE.
- ① DO NOT TOUCH THE POWER CORD, ELECTRICAL SOCKET OR POWER OUTLET WITH WET HANDS TO AVOID ELECTRICAL SHOCK OR FIRE.
- ① DO NOT BEND OR PINCH POWER CORD OR PLACE UNDER HEAVY OBJECTS THAT MIGHT DAMAGE IT. THIS COULD RESULT IN ELECTRICAL SHOCK OR DAMAGE BY FIRE.
- ① DO NOT USE MULTI-SOCKET POWER OUTLET TO PLUG IN IONIZER, ESPECIALLY IF IT IS BEING USED TO POWER UP OTHER APPLIANCES. THIS COULD RESULT IN ELECTRICAL DAMAGE OR FIRE.
- ① DO NOT ATTEMPT TO REPAIR THE POWER CORD. DISCONNECT THE POWER OUTLET AND CONTACT TECHNICAL SUPPORT FOR REPLACEMENT.
- ① MAKE SURE THAT THE POWER OUTLET SOCKET HAS A GROUND CONNECTION.
- ① DO NOT TOUCH THE ELECTRICAL SOCKET WITH WET HANDS TO AVOID ELECTRICAL SHOCK OR FIRE.
- ① DO NOT CLEAN THE IONIZER USING WATER SPRAY - IT COULD CAUSE AN ELECTRICAL SHOCK. ALWAYS DISCONNECT THE IONIZER FROM THE ELECTRICITY BEFORE CLEANING.
- ① DO NOT USE CABLES OR PLUGS WORN WITH USE AND DO NOT ATTEMPT TO REMODEL THEM. DO NOT TWIST THE CABLE, BEND IT, STRETCH IT, NOR MAKE ANY KNOTS OR PLACE HEAVY OBJECTS ON IT. YOU RUN THE RISK OF ELECTRIC SHOCK OR SHORT CIRCUIT.
- ① REGULARLY CLEAN THE SOCKET FROM DUST. IF THE SOCKET IS DUSTY, CLEAN IF FIRST BEFORE INSERTING THE PLUG. IF DUST GETS INTO THE SOCKET, IT INCREASES THE RISK OF ELECTRIC SHOCK DUE TO HIGHER HUMIDITY LEVELS.
- ① THE PLUG MUST BE PLUGGED IN COMPLETELY.
- ① PJ7000 REPLACEMENT FILTER MUST BE REPLACED AT LEAST EVERY 12 MONTHS OR AFTER USING 10,000 LITRES OF WATER. YOUR DEALER WILL PROVIDE YOU WITH GENUINE REPLACEMENT FILTERS.
- ① IF THE DEVICE FALLS INTO WATER, UNPLUG IT FROM THE POWER OUTLET, STOP USING IT AND FOLLOW THESE INSTRUCTIONS:

○ *Your path to healthy water*



- ① 1. DISCONNECT THE POWER SOURCE; 2. DRY THE DEVICE; 3. CONTACT YOUR DEALER.
- ① IF THERE IS AN UNUSUAL SITUATION LIKE SMOKE OR WATER LEAKAGE FROM THE DEVICE, UNPLUG IT FROM THE POWER AND TURN OFF THE WATER VALVE.
- ① DO NOT USE ALKALINE WATER TO SWALLOW MEDICINE.
- ① DO NOT DRINK ACIDIC WATER (PH VALUE LOWER THAN 7.0).
- ① DO NOT USE IONIZER FOR UNSUITABLE WATER – WATER FROM WELLS, VERY HARD WATER, AND WATER WITH A LARGE AMOUNT OF SEDIMENT OR HIGH LEVEL OF UNDISSOLVED SOLIDS. ALWAYS CONSULT YOUR DEALER FIRST.
- ① DO NOT STORE ALKALINE WATER IN BRONZE OR ALUMINIUM CONTAINERS. IT IS RECOMMENDED TO USE PRIMARILY GLASS OR CERAMIC CONTAINERS FOR STORAGE.
- ① DO NOT USE WATER WITH A TEMPERATURE HIGHER THAN 40°C – IT CAN CAUSE DAMAGE TO THE FILTERS IN THE DEVICE.
- ① PROTECT THE DEVICE FROM FROST, DIRECT SUNLIGHT AND HEATING.
- ① IF YOU KNOW THAT YOU WILL NOT BE USING IONIZER FOR A PERIOD LONGER THAN ONE DAY, UNPLUG THE DEVICE FROM THE POWER OUTLET AND CLOSE THE WATER VALVE TO PREVENT LEAKAGE. IF YOU ARE NOT GOING TO USE THE DEVICE FOR AN EXTENDED PERIOD OF TIME, REMOVE THE FILTERS, DRY THEM AND KEEP THEM IN THE FRIDGE.
- ① ALKALINE OR FILTERED WATER STORE IN CLEAN, CLOSED CONTAINERS. WHEN STORED AT ROOM TEMPERATURE, THE WATER SHOULD BE USED WITHIN 1 DAY, WHEN STORED IN THE FRIDGE, IT SHOULD BE USED WITHIN 2 DAYS.
- ① IF IT IS YOUR FIRST TIME DRINKING ALKALINE LIVING WATER, THE RECOMMENDED DOSAGE IS 1 OR 2 GLASSES OF ALKALINE 1 WATER LEVEL. AFTER 2 WEEKS, WHEN YOUR BODY GETS USED TO ALKALINE LIVING WATER, IT IS POSSIBLE TO MOVE TO A HIGHER LEVEL OF IONIZATION (ALKALINE 2 OR 3).
- ① DRINKING HIGHLY ALKALINE WATER (PH VALUE HIGHER THEN 10) CAN CAUSE DISCOMFORT.
- ① IT IS PROHIBITED TO DISMANTLE THE DEVICE. DO NOT REPAIR IT, REMODEL IT, OR ALTER ITS FUNCTION – YOU RUN THE RISK OF ELECTRIC SHOCK, FIRE AND WARRANTY VOID.



TROUBLESHOOTING

PROBLEM	CAUSE	SOLUTION
Internal leak from device	Find out where the leak is coming from.	Contact your dealer for assistance.
Leak from inlet or outlet fitting	Check fitting and tube to identify where exactly the leak is coming from.	Remove the tube and check that the shape is round and the cut is straight and not at an angle and reconnect to fitting making sure it goes as far in as possible.
Measured values are not what they should be	pH reagent drops might be expired or dysfunctional.	Contact your dealer and order new pH testing drops.
	The water flow might be too high.	Reduce flow as needed.
	Calcium build-up might be present.	In hard water areas it is recommended to perform citric acid flushes in addition to self-cleaning cycles to reduce build-ups. The frequency of flushes depends on the hardness of the water.



Bleach smell from acid water	Making acid water might produce hypochlorous acid which is what gives the water its bleachy smell.	The smell is harmless to the skin.
White flakes in the alkaline water	The ionization process concentrates the calcium in the water.	This is harmless. You can use the water.
	Calcium build-up on electroplates.	In hard water areas, it is recommended to perform citric acid flushes in addition to self-cleaning cycles to reduce build-ups. The frequency of flushes depends on the hardness of the water.
Restriction of water flow	Check the side flow control valve, water diverter valve and main shut off valve.	If any of these are closed or partially closed, water flow will be restricted.
	Have the filters been changed?	If the filters haven't been changed, the flow restriction could be an indication of the need to replace the filters. Dirt and debris clog the filter, thus reducing water flow.
	White flakes in water due to calcium build-ups.	In hard water areas, it is recommended to perform citric acid flushes in addition to self-cleaning cycles to reduce the build-ups.



Water dripping from drain outlet after use	Verify if it stops after a few seconds after turning the ionizer off.	This is normal as there will be still water inside the ionizer after being turned off, especially from the drain. If a long time has passed after using the ionizer and the water is still dripping, contact your dealer for further assistance.
Bad odor coming out of ionizer	Check if filters have been replaced.	Contact your dealer to purchase new filters.
Restriction of water flow	Check the side flow control valve, water diverter valve and main shut off valve.	If any of these are closed or partially closed, water flow will be restricted.
	Have the filters been changed?	If the filters haven't been changed, the flow restriction could be an indication of the need to replace the filters. Dirt and debris clog the filter, thus reducing water flow.
	White flakes in water due to calcium build-ups.	In hard water areas, it is recommended to perform citric acid flushes in addition to self-cleaning cycles to reduce the build-ups.
Ionizer cannot be turned on	Check the ionizer's fuse.	Contact your dealer.
Ionizer stops working suddenly and turns itself off	Has the ionizer been in use for longer period of time?	If so, remember that the ionizer will shut itself off after 15 minutes of use.
	Verify if there was no overheating error on the screen.	If so, wait 60 minutes before using the ionizer again to allow enough time for the ionizer to cool down.

Your path to healthy water

SPECIFICATIONS

MODEL	VS-A705
RATED VOLTAGE/FREQUENCY	240 V/ 50-60 HZ
POWER	185W
IONIZER DIMENSIONS	247 × 157 × 305 (WIDTH X DEPTH X HEIGHT IN MM)
FAUCET DIMENSIONS	115 × 180 × 242 (WIDTH X DEPTH X HEIGHT IN MM)
IONIZER WEIGHT	3,4 KG
FAUCET WEIGHT	1,3 KG
MAXIMUM WATER PRESSURE	8-70 PSI
WATER TEMPERATURE	5-40°C / 41-104°F

CHANSON WATER FILTRATION SYSTEMS

- EASY AND QUICK INSTALLATION
- ENSURE THE BEST WATER QUALITY
- BEST FIT WITH CHANSON WATER IONIZERS



N5 PLUS



P1



SHOWER FILTER



"Your path to healthy water"



